

Copyright and ownership of this drawing is vested in Brinkmann & Niemeijer Motoren B.V., whose prior written consent is required for its use, reproduction or for publication to any third party. All other rights reserved.

Changings reserved

440 kVA

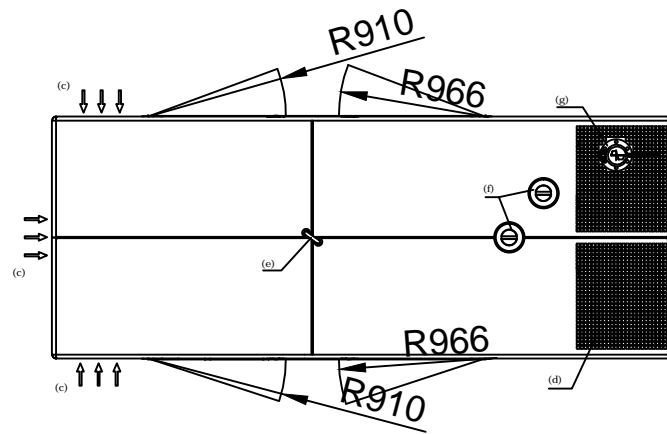

- (a) Acces to drain
- (b) Mounting on floor (4x ø22 mm)
- (c) Air inlet
- (d) Air outlet
- (e) Lifting point
- (f) Radiator acces
- (g) Exhaust outlet ø140 mm
- (h) For external fuel supply, connections ø42 mm
- (i) Cable gland

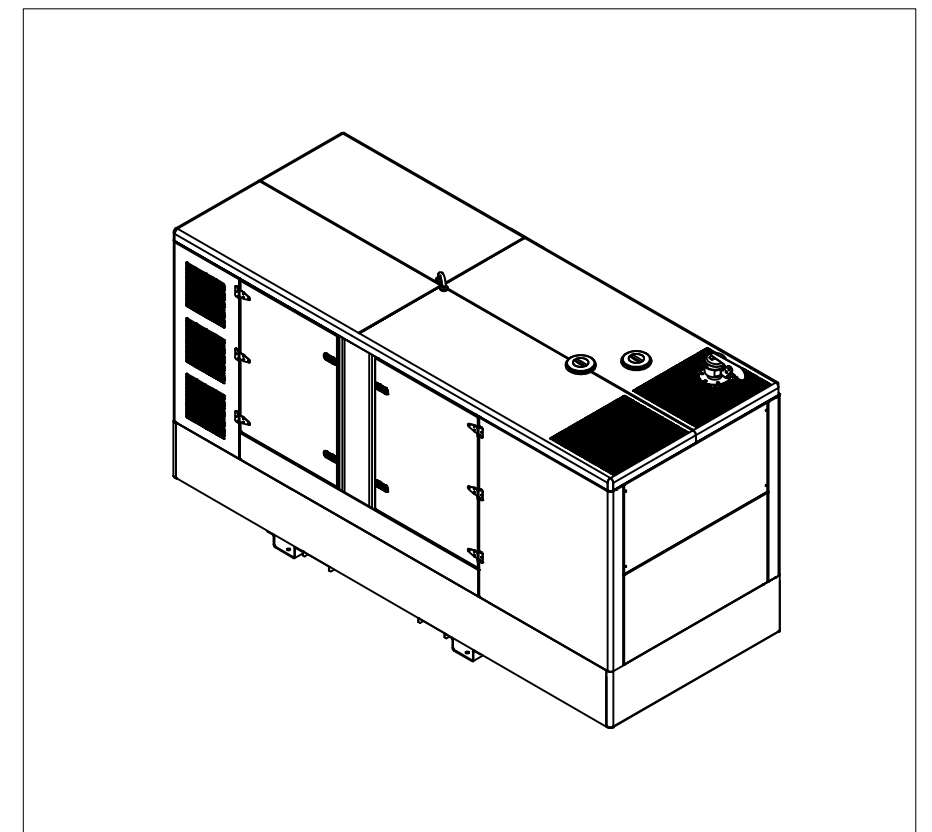
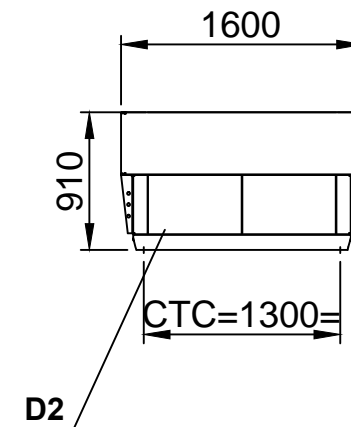
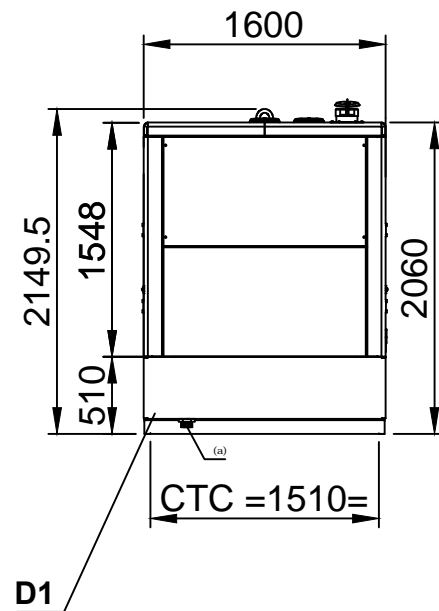
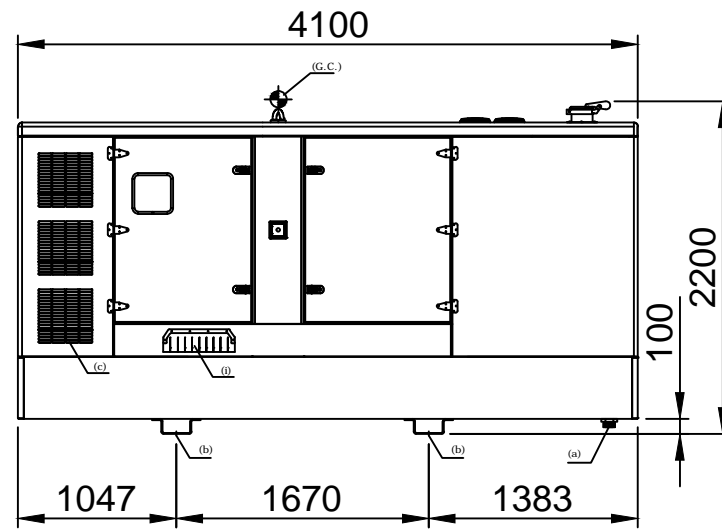

Optional:
 D1: Overall dimensions 4100x1600x2200 mm Tank capacity 597 ltr
 D2: Overall dimensions 4100x1600x2600 mm Tank capacity 1660 ltr

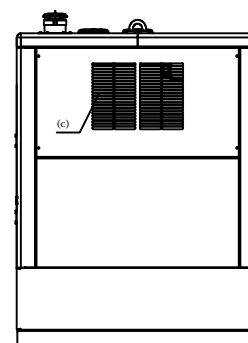
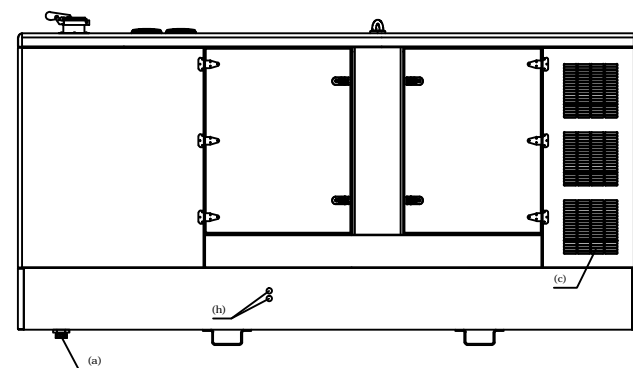

Deze tekening blijft eigendom van Brinkmann & Niemeijer Motoren B.V. en mag zonder haar schriftelijke toestemming niet gecopieerd worden of aan derden ter inzage worden gegeven. Alle overige rechten voorbehouden.

Wijzigingen voorbehouden

Scania DC12 59A(10-33A)

RUWHEID VOLGENS NEN 3634	ISO-PASSINGSTELSEL NEN-ISO 286-1 EN-2	VORM- EN PLAATSTOLERANTIES VOLGENS NEN-ISO 1101		
AMERIKAANSE PROJECTIE	SCHAAL: 1:50	GETEKEND: DJ	OPMERKINGEN:	
	MAATEENHEID: MM	AFDELING: Engineering		
DATUM: 21-12-2009	GEZIEN:			
BRINKMANN & NIEMEIJER MOTOREN BV		BENAMING: G441QX	TEK.NR.: C151073 ^A	FORMAAT: A3