

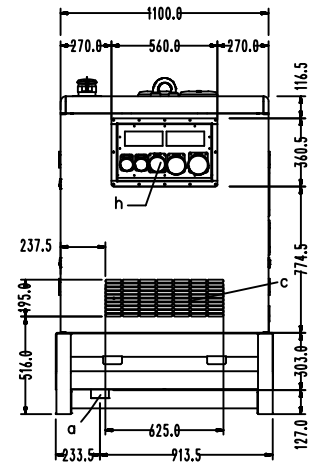

# 60 kVA

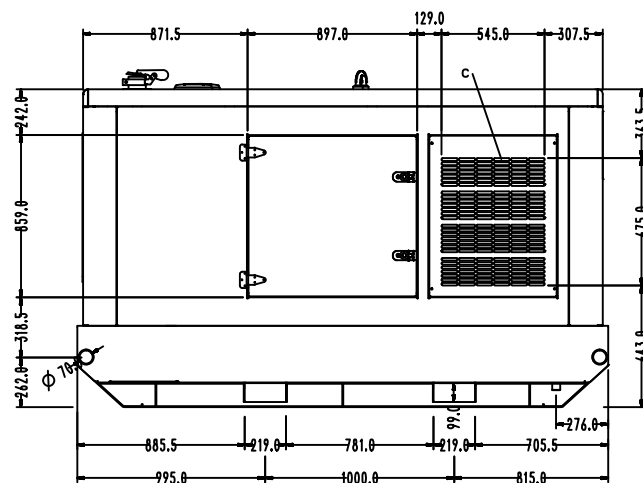

- (a) Acces to drain
- (b) Mounting on floor (4x ø14 mm)
- (c) Air inlet
- (d) Emergency stop
- (e) Lifting point
- (f) Radiator access
- (g) Exhaust outlet
- (h) Receptacle box CBR10 (optional)
- (i) Cable gland
- (j) External fuel supply
- (k) External fuel supply connections 3 way manifold (option)
- (l) Drain baseframe
- (m) Sledging skid
- (n) Oil drain

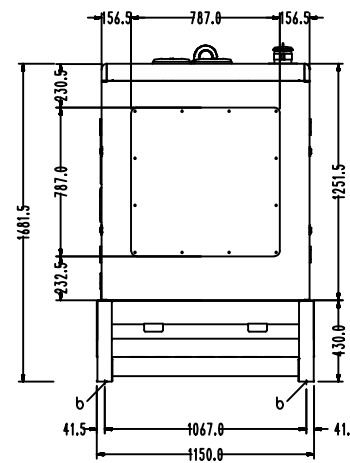
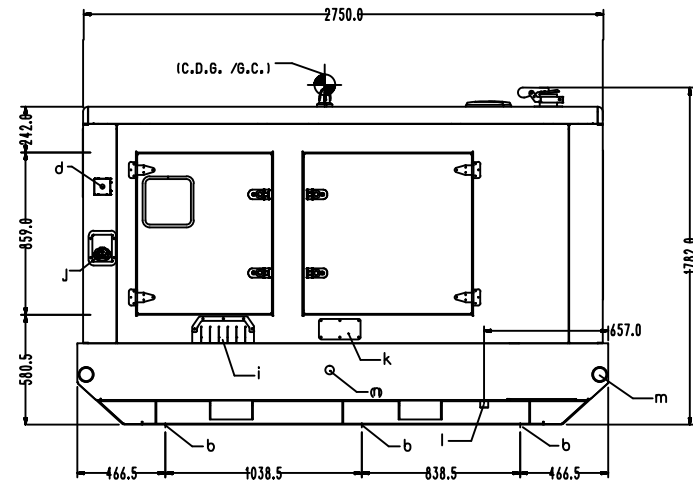
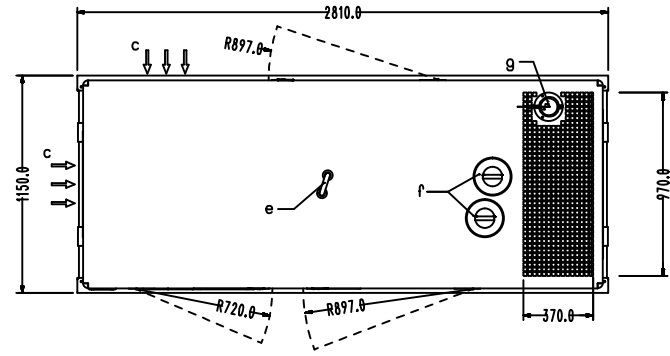
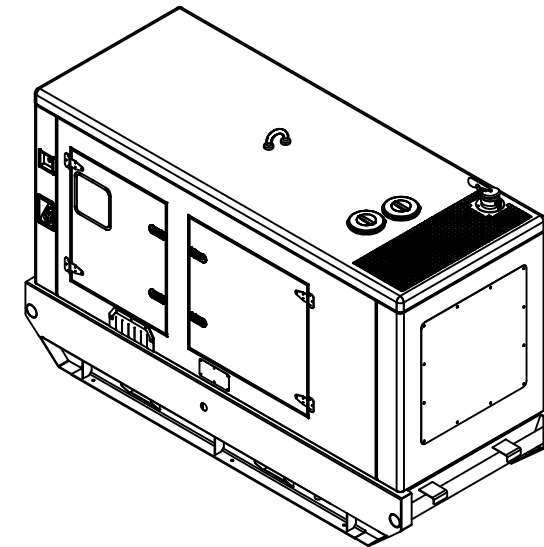
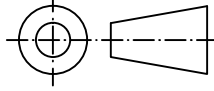

RUWHEID VOLGENS NEN 3634	ISO-PASSINGSTELSEL NEN-ISO 286-1 EN-2		VORM- EN PLAATSTOLERANTIES VOLGENS NEN-ISO 1101
AMERIKAANSE PROJECTIE 	SCHAAL: 1:40	GETEKEND: DJ	OPMERKINGEN:
	MAATEENHEID: MM	AFDELING: Engineering	
	DATUM: 21-09-2012	GEZIEN:	
BRINKMANN & NIEMEIJER MOTOREN BV 		BENAMING: G61RX	TEK.NR.: C151092 <sup>A</sup>
			FORMAAT: A3