

Copyright and ownership of this drawing is vested in Brinkmann & Niemeijer Motoren B.V., whose prior written consent is required for its use, reproduction or for publication to any third party. All other rights reserved.

Changings reserved

41 kVA

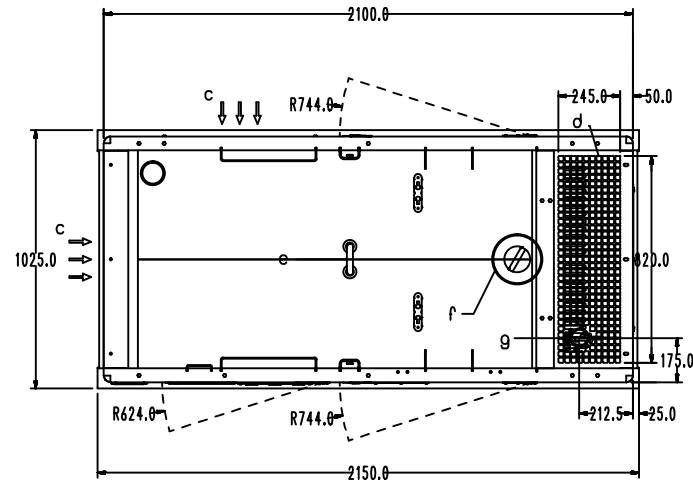

- (a) Access to drain
- (b) Mounting on floor (4x ø16 mm)
- (c) Air inlet
- (d) Air outlet
- (e) Lifting point
- (f) Radiator access
- (g) Exhaust outlet ø65 mm
- (h) External fuel supply
- (i) Emergency stop
- (j) Cable gland
- (k) External fuel supply connections 3 way manifold (optional)
- (l) Receptacle box (optional)

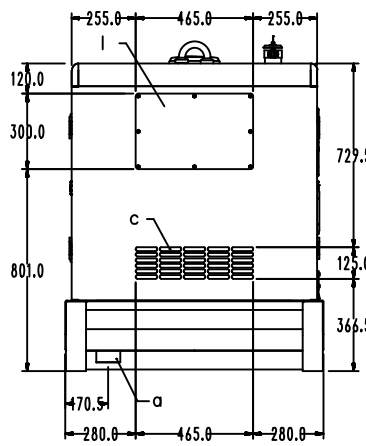
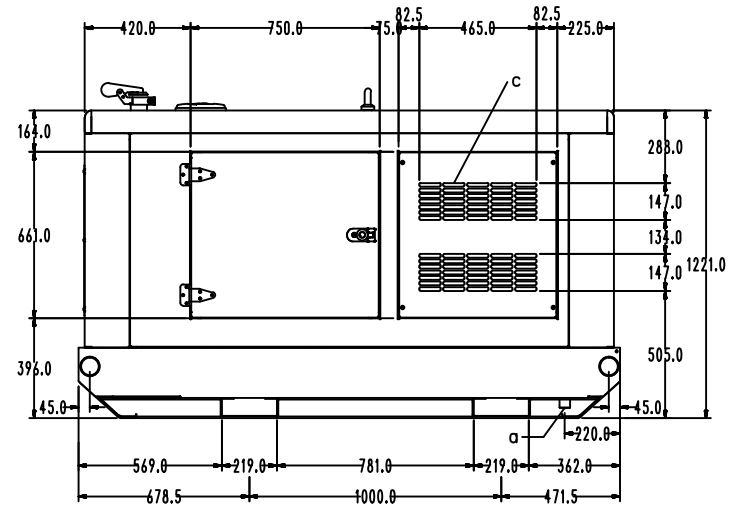
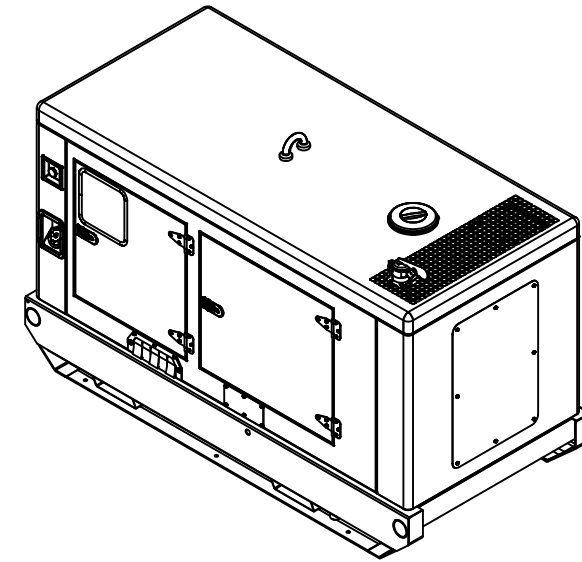
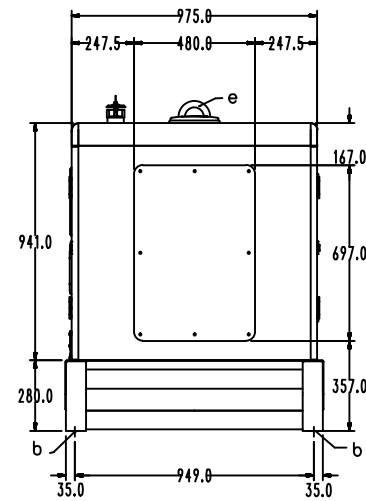
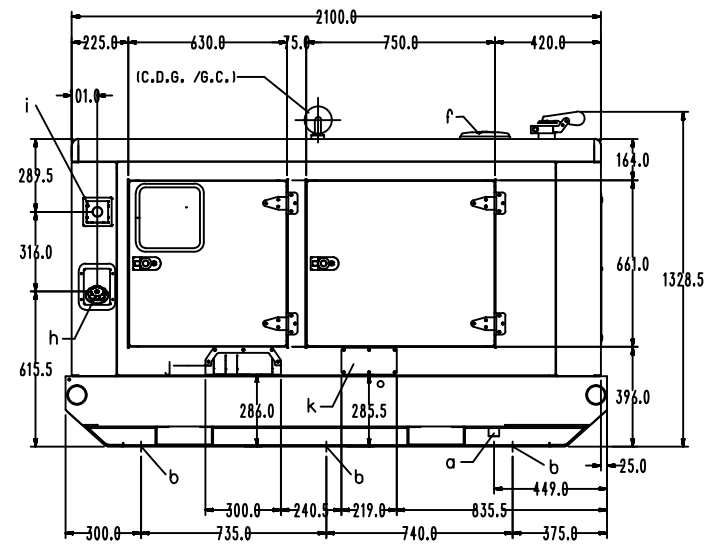

Deze tekening blijft eigendom van Brinkmann & Niemeijer Motoren B.V. en mag zonder haar schriftelijke toestemming niet gecopieerd worden of aan derden ter inzage worden gegeven. Alle overige rechten voorbehouden.

Wijzigingen voorbehouden

Yanmar 4TNV98T

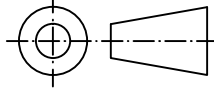
RUWHEID VOLGENS NEN 3634	ISO-PASSINGSTELSEL NEN-ISO 286-1 EN-2	VORM- EN PLAATSTOLERANTIES VOLGENS NEN-ISO 1101	
AMERIKAANSE PROJECTIE	SCHAAL: 1:30	GETEKEND: DJ	OPMERKINGEN:
	MAATEENHEID: MM	AFDELING: Engineering	
	DATUM: 25-09-2012	GEZIEN:	
BRINKMANN & NIEMEIJER MOTOREN BV		BENAMING: G41RX	TEK.NR.: C151090 ^A
			FORMAAT: A3