

Copyright and ownership of this drawing is vested in Brinkmann & Niemeijer Motoren B.V., whose prior written consent is required for its use, reproduction or for publication to any third party. All other rights reserved.

Changings reserved

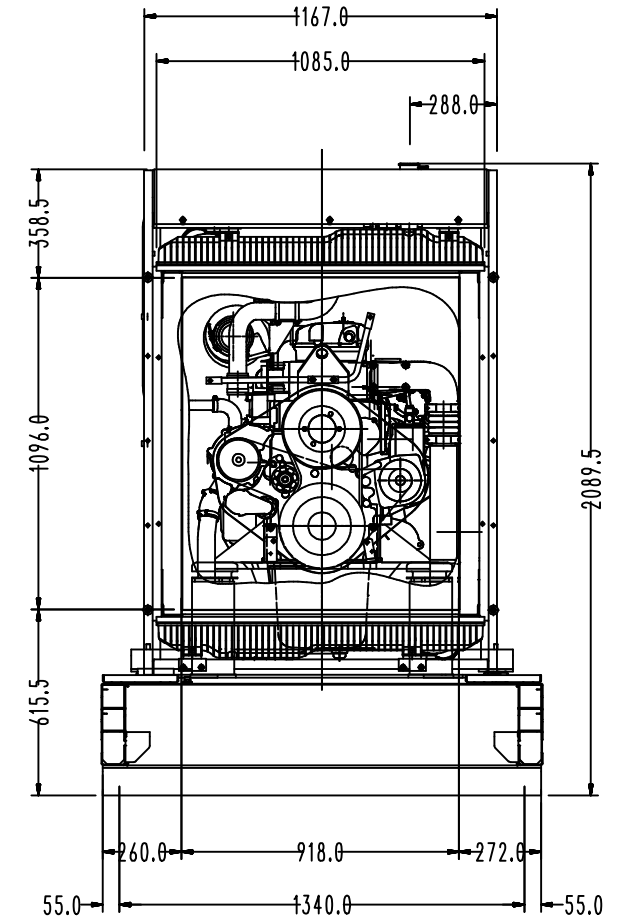

350 kVA

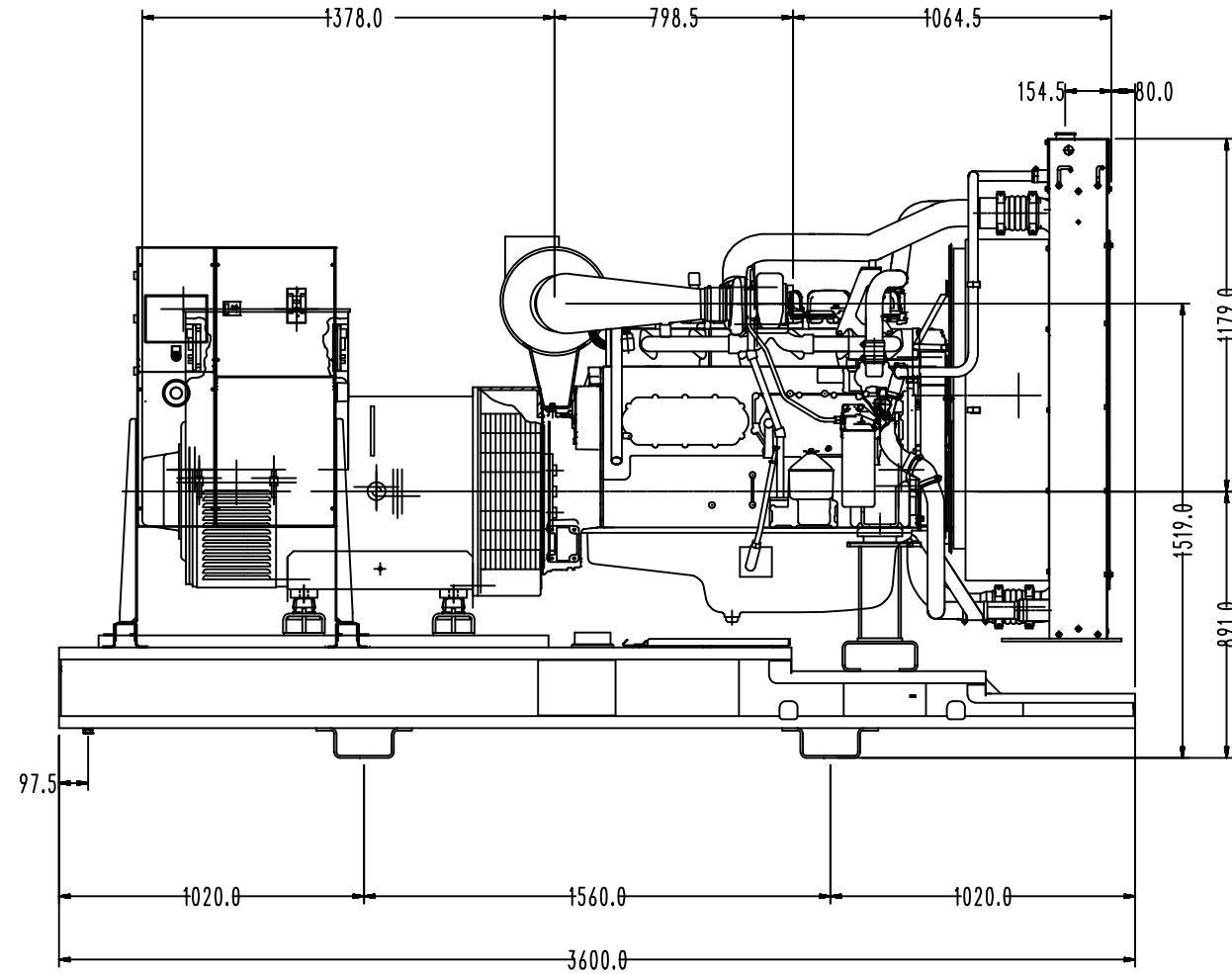
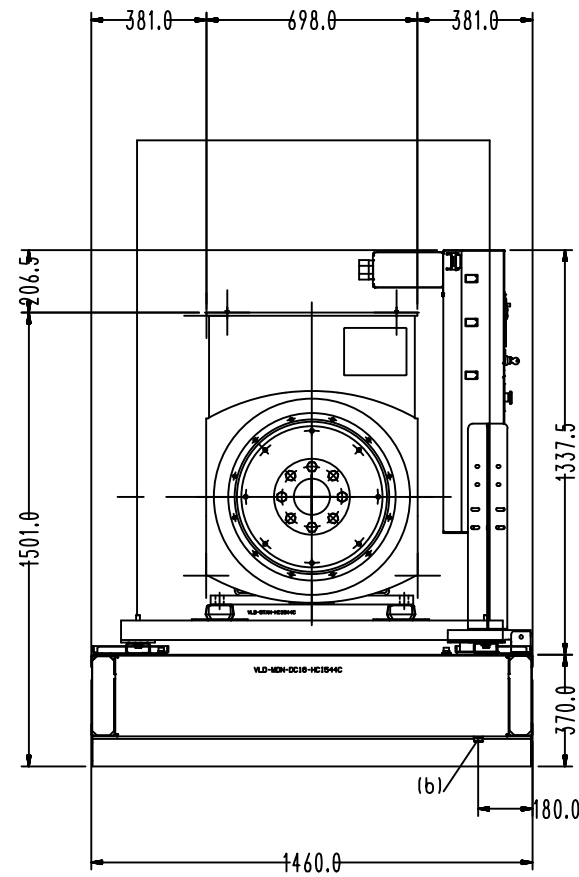

Deze tekening blijft eigendom van Brinkmann & Niemeijer Motoren B.V. en mag zonder haar schriftelijke toestemming niet gecopieerd worden of aan derden ter inzage worden gegeven. Alle overige rechten voorbehouden.

Wijzigingen voorbehouden

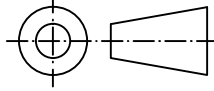
Engine	Alternator	L	
		Without PMG	With PMG
Scania DC12-60A	HM280B3	-	-

RUWHEID VOLGENS NEN 3634	ISO-PASSINGSTELSEL NEN-ISO 286-1 EN-2		VORM- EN PLAASTOLERANTIES VOLGENS NEN-ISO 1101
AMERIKAANSE PROJECTIE	SCHAAL: 1:25	GETEKEND: DJ	OPMERKINGEN:
	MAATEENHEID: MM	AFDELING: Engineering	
	DATUM: 01-06-2010	GEZIEN:	
		BENAMING: G401X Open set	TEK.NR.: C151029 ^A
			FORMAAT: A3